

PQ20WZ51/PQ20WZ11

Variable Output, General Purpose, Surface Mount Type Low Power-Loss Voltage Regulator

■ Features

- Low power-loss
(Dropout voltage : MAX. 0.5V)
- Surface mount package (equivalent to SC-63)
- Variable output voltage (3.0 to 20V)
- Output current (0.5A : PQ20WZ51)
(1.0A : PQ20WZ11)
- Reference voltage precision : $\pm 2.5\%$
- Built-in ON/OFF control function
- Low dissipation current at OFF-state (I_{qs} : MAX. 5 μ A)
- Built-in overcurrent, overheat protection functions, ASO protection circuit
- Available tape-packaged products
($\phi 330$ mm reel : 3 000 pcs., PQ20WZ5U/1U)

■ Applications

- Personal computers
- CD-ROM drives
- Power supplies for various OA equipment

■ Outline Dimensions

(Unit : mm)

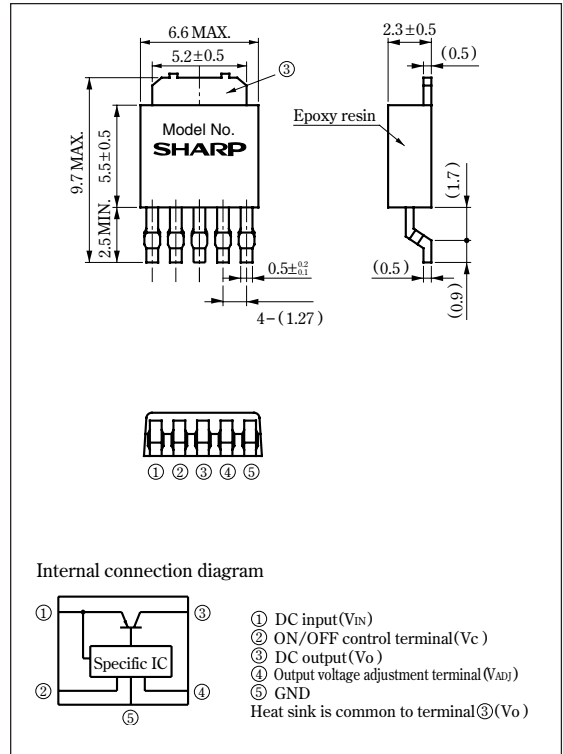

■ Absolute Maximum Ratings

($T_a=25^\circ\text{C}$)

Parameter	Symbol	Rating		Unit
		PQ20WZ51	PQ20WZ11	
*1 Input voltage	V_{IN}	24		V
*1 ON/OFF control terminal voltage	V_c	24		V
*1 Output adjustment terminal voltage	V_{ADJ}	5		V
Output current	I_o	0.5	1.0	A
Power dissipation (with infinite heat sink)	P_D	8		W
*2 Junction temperature	T_j	150		$^\circ\text{C}$
Operating temperature	T_{opr}	-20 to +80		$^\circ\text{C}$
Storage temperature	T_{stg}	-40 to +150		$^\circ\text{C}$
*3 Soldering temperature	T_{sol}	260		$^\circ\text{C}$

*1 All are open except GND and applicable terminals.

*2 Overheat protection may operate at $125 \leq T_j \leq 150^\circ\text{C}$

*3 For 10s

• Please refer to the chapter " Handling Precautions ".

SHARP

Notice In the absence of confirmation by device specification sheets, SHARP takes no responsibility for any defects that may occur in equipment using any SHARP devices shown in catalogs, data books, etc. Contact SHARP in order to obtain the latest device specification sheets before using any SHARP device.
Internet Internet address for Electronic Components Group <http://sharp-world.com/ecg/>

Electrical Characteristics

(Unless otherwise specified, conditions shall be $V_{IN}=5V$, $V_o=3.3V$,^{#4}, $R_1=2k\Omega$, $R_2=500\Omega$, $V_C=2.7V$, $T_a=25^\circ C$)

Parameter	Symbol	Conditions	MIN.	TYP.	MAX.	Unit
Input voltage	V_{IN}	—	3.5	—	24	V
Output voltage	V_o	—	3.0	—	20	V
Load regulation	R_{egL}	$\#5$	—	—	2.0	%
Line regulation	R_{egI}	$V_{IN}=4$ to $10V$, $I_o=5mA$	—	—	2.5	%
Ripple rejection	RR	Refer to Fig. 2	45	60	—	dB
Reference voltage	V_{ref}	$\#4$	2.574	2.64	2.706	V
Temperature coefficient of Reference voltage	$V_C V_{ref}$	$T_j=0$ to $125^\circ C$, $I_o=5mA$	—	± 1.0	—	%
Dropout voltage	V_{I-o}	$\#4, 6$	—	—	0.5	V
Quiescent current	I_q	$I_o=0A$	—	—	8	mA
^{#7} ON-state voltage for control	$V_C(ON)$	—	2.0	—	—	V
ON-state current for control	$I_C(ON)$	—	—	—	200	μA
OFF-state voltage for control	$V_C(OFF)$	$I_o=0A$	—	—	0.8	V
OFF-state current for control	$I_C(OFF)$	$I_o=0A$, $V_C=0.4V$	—	—	2.0	μA
Output OFF-state consumption current	I_{qs}	$I_o=0A$, $V_C=0.4V$	—	—	5.0	μA

^{#4} PQ20WZ51: $I_o=0.3A$, PQ20WZ11: $I_o=0.5A$

^{#5} PQ20WZ51: $I_o=5mA$ to $0.5A$, PQ20WZ11: $I_o=5mA$ to $1.0A$

^{#6} Input voltage shall be the value when output voltage is 95% in comparison with the initial value.

^{#7} In case of opening control terminal ②, output voltage turns off.

Fig. 1 Test Circuit

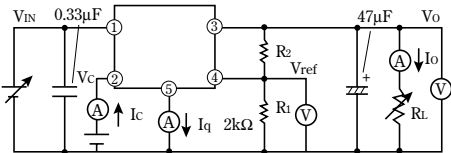

$$V_o = V_{ref} \times \left(1 + \frac{R_2}{R_1} \right)$$

[$R_1=2k\Omega$, V_{ref} Nearly =2.64V]

Fig. 2 Test Circuit for Ripple Rejection

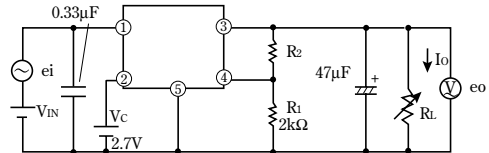

$f=120Hz$ (sine wave)
 $e_i(rms)=0.5V$
 $I_o=0.3A$
 $RR=20 \log(e_i(rms)/e_o(rms))$
 $V_{IN}=5V$
 $V_o=3.3V$ ($R_1=2k\Omega$)

Fig. 3 Power Dissipation vs. Ambient Temperature

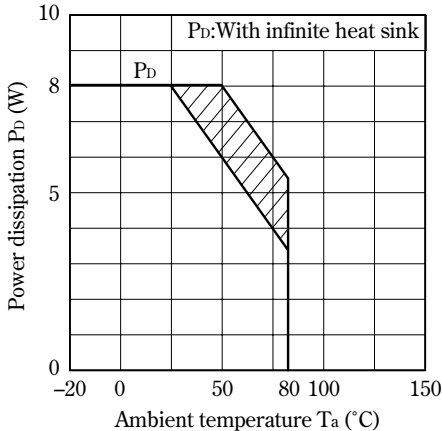

Note) Oblique line portion : Overheat protection may operate in this area.

Fig. 4 Overcurrent Protection Characteristics (Typical Value) (PQ20WZ51)

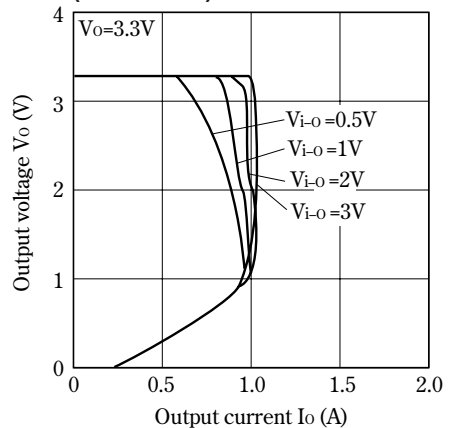

Fig. 5 Overcurrent Protection Characteristics (Typical Value) (PQ20WZ11)

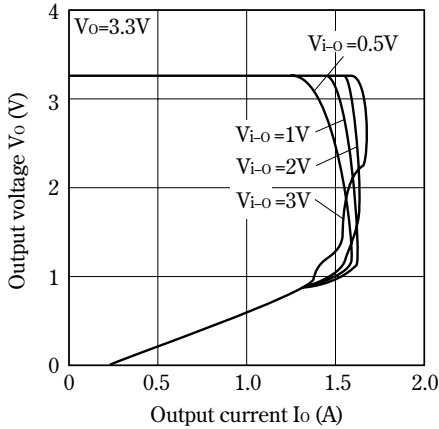

Fig. 6 Output Voltage Adjustment Characteristics

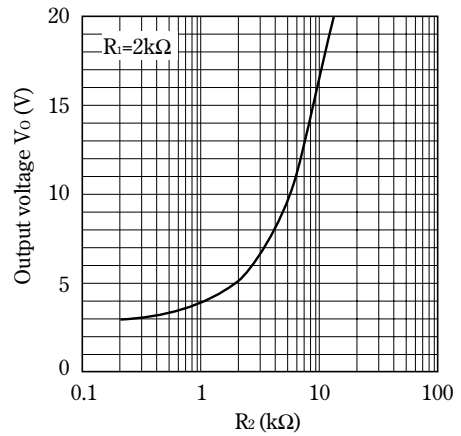

Fig. 7 Reference Voltage Deviation vs. Junction Temperature (Typical Value)

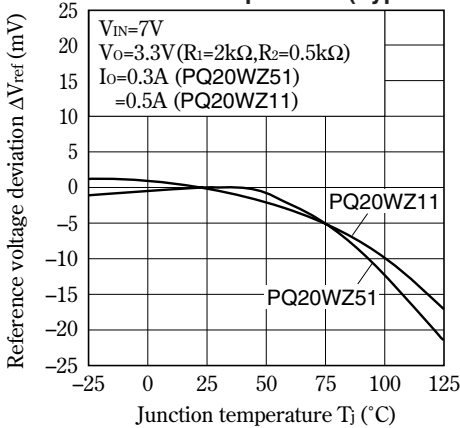

Fig. 8 Output Voltage vs. Input Voltage (PQ20WZ51)

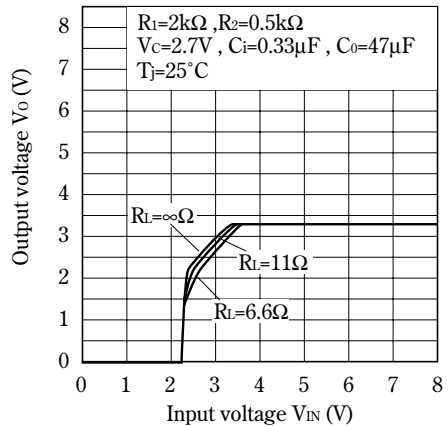

Fig. 9 Output Voltage vs. Input Voltage (PQ20WZ11)

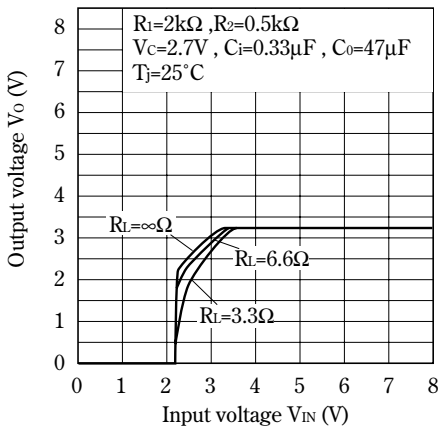

Fig.10 Dropout Voltage vs. Junction Temperature (PQ20WZ51)

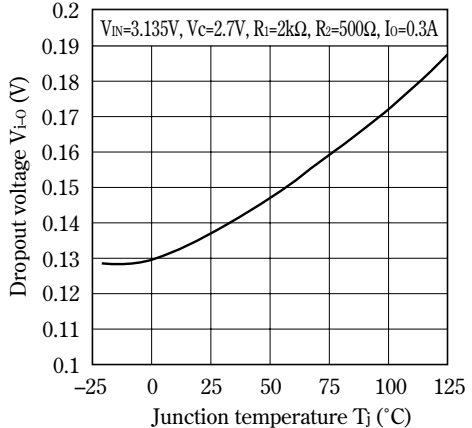

Fig.11 Dropout Voltage vs. Junction Temperature (PQ20WZ11)

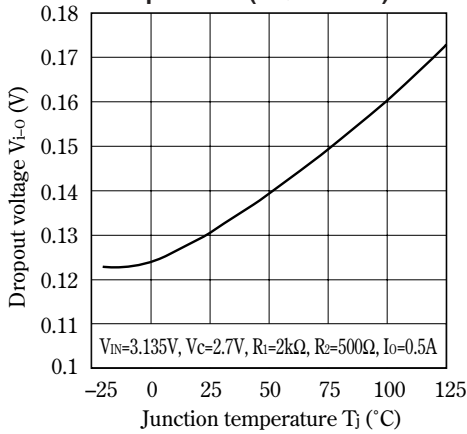

Fig.12 Quiescent Current vs. Junction Temperature

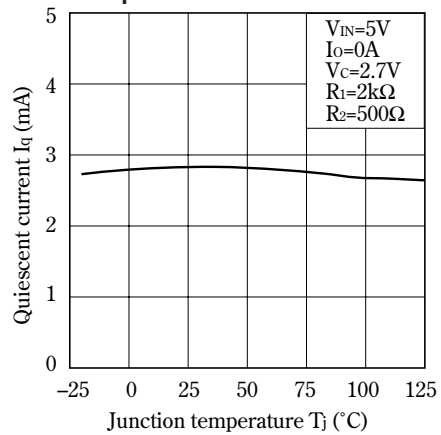

Fig.13 Ripple Rejection vs. Input Ripple Frequency

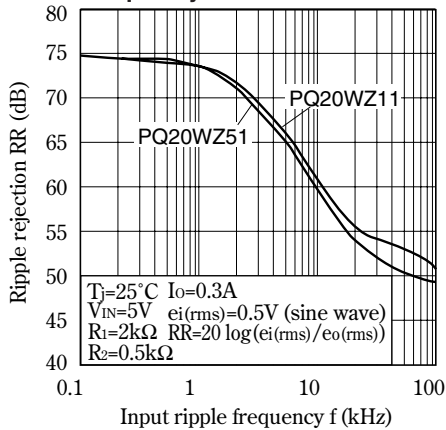

Fig.14 Ripple Rejection vs. Output Current (PQ20WZ51)

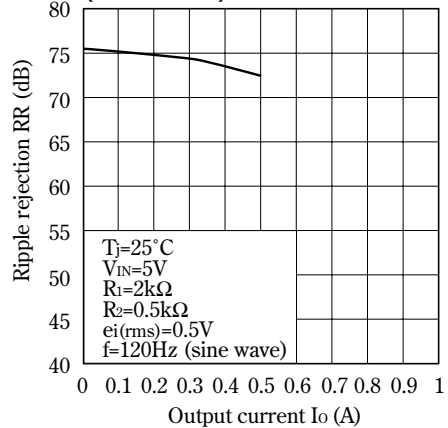

Fig.15 Ripple Rejection vs. Output Current (PQ20WZ11)

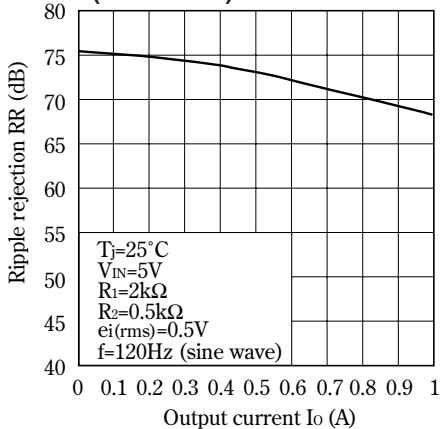

Fig.16 Circuit Operating Current vs. Input Voltage (PQ20WZ51)

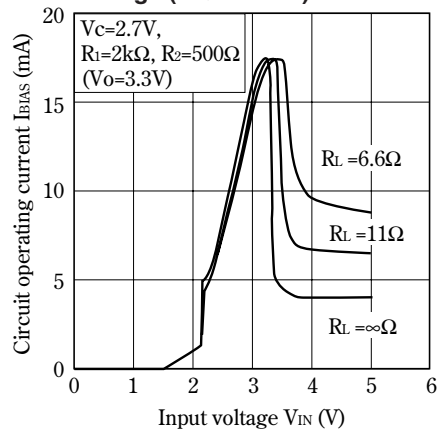

Fig.17 Circuit Operating Current vs. Input Voltage (PQ20WZ11)

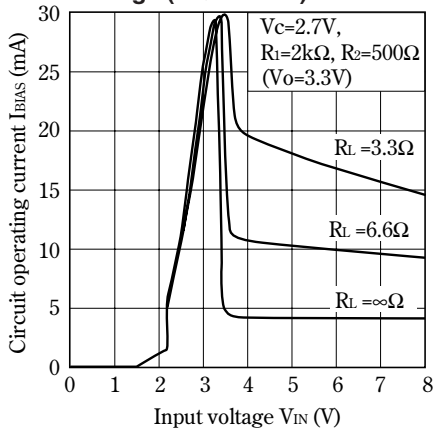
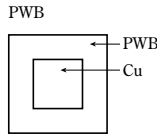
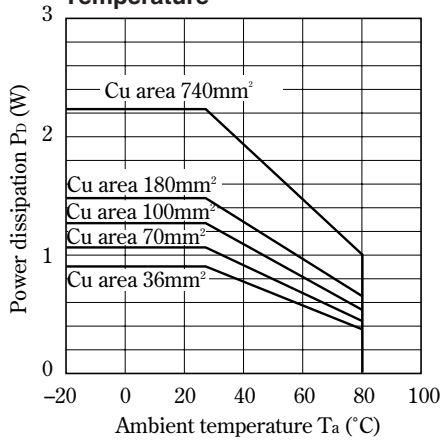
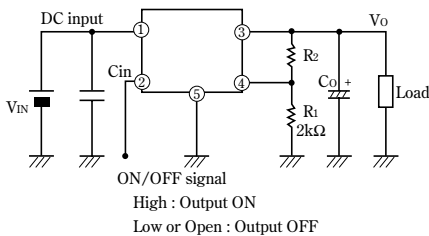

Fig.18 Power Dissipation vs. Ambient Temperature



Material : Glass-cloth epoxy resin
 Size : 50 X 50 X 1.6mm
 Cu thickness : 35μm

Typical Application



Model Line-ups for Tape-packaged Products

	Sleeve-packaged products	Tape-packaged products
Output current	High-precision output type	High-precision output type
0.5A output	PQ20WZ51	PQ20WZ5U
1.0A output	PQ20WZ11	PQ20WZ1U

NOTICE

- The circuit application examples in this publication are provided to explain representative applications of SHARP devices and are not intended to guarantee any circuit design or license any intellectual property rights. SHARP takes no responsibility for any problems related to any intellectual property right of a third party resulting from the use of SHARP's devices.
- Contact SHARP in order to obtain the latest device specification sheets before using any SHARP device. SHARP reserves the right to make changes in the specifications, characteristics, data, materials, structure, and other contents described herein at any time without notice in order to improve design or reliability. Manufacturing locations are also subject to change without notice.
- Observe the following points when using any devices in this publication. SHARP takes no responsibility for damage caused by improper use of the devices which does not meet the conditions and absolute maximum ratings to be used specified in the relevant specification sheet nor meet the following conditions:
 - (i) The devices in this publication are designed for use in general electronic equipment designs such as:
 - Personal computers
 - Office automation equipment
 - Telecommunication equipment [terminal]
 - Test and measurement equipment
 - Industrial control
 - Audio visual equipment
 - Consumer electronics
 - (ii) Measures such as fail-safe function and redundant design should be taken to ensure reliability and safety when SHARP devices are used for or in connection with equipment that requires higher reliability such as:
 - Transportation control and safety equipment (i.e., aircraft, trains, automobiles, etc.)
 - Traffic signals
 - Gas leakage sensor breakers
 - Alarm equipment
 - Various safety devices, etc.
 - (iii) SHARP devices shall not be used for or in connection with equipment that requires an extremely high level of reliability and safety such as:
 - Space applications
 - Telecommunication equipment [trunk lines]
 - Nuclear power control equipment
 - Medical and other life support equipment (e.g., scuba).
- If the SHARP devices listed in this publication fall within the scope of strategic products described in the Foreign Exchange and Foreign Trade Law of Japan, it is necessary to obtain approval to export such SHARP devices.
- This publication is the proprietary product of SHARP and is copyrighted, with all rights reserved. Under the copyright laws, no part of this publication may be reproduced or transmitted in any form or by any means, electronic or mechanical, for any purpose, in whole or in part, without the express written permission of SHARP. Express written permission is also required before any use of this publication may be made by a third party.
- Contact and consult with a SHARP representative if there are any questions about the contents of this publication.